



This report provided free of charge by:

Big Jons Auto

2815 W 8th Ave, Denver, CO 80204

833-339-0850



Vehicle History Report™

US \$39.99

2007 NISSAN ALTIMA 2.5/2.5 S

VIN: 1N4AL21E37C161216
 SEDAN 4 DR
 2.5L I4 F DOHC 16V
 GASOLINE
 FRONT WHEEL DRIVE



Moderate damage

4 Previous owners

19 Service history records

Types of owners: Rental, Personal

Last owned in Colorado

126,642 Last reported odometer reading

CARFAX HAS THE MOST ACCIDENT & DAMAGE INFORMATION



This CARFAX Report Provided by:

Big Jons Auto

This CARFAX Vehicle History Report is based only on information supplied to CARFAX and available as of 7/14/21 at 7:33:33 AM (CDT). Other information about this vehicle, including problems, may not have been reported to CARFAX. Use this report as one important tool, along with a vehicle inspection and test drive, to make a better decision about your next used car.



Ownership History

The number of owners is estimated

Year purchased	2007	Owners 1-2	Owner 3	Owner 4
Type of owner	See Details	Personal	Personal	Personal
Estimated length of ownership	3 yrs. 9 mo.	5 yrs. 11 mo.	4 yrs. 5 mo.	4 yrs. 5 mo.
Owned in the following states/provinces	Arizona, Arizona	Arizona, Colorado	Colorado	Colorado
Estimated miles driven per year	See Details	11,787/yr	5,181/yr	5,181/yr
Last reported odometer reading	20,604	99,053	126,642	126,642



Title History

CARFAX guarantees the information in this section

Salvage Junk Rebuilt Fire Flood Hail Lemon	<input checked="" type="checkbox"/> Guaranteed No Problem	<input checked="" type="checkbox"/> Guaranteed No Problem	<input checked="" type="checkbox"/> Guaranteed No Problem	<input checked="" type="checkbox"/> Guaranteed No Problem
Not Actual Mileage Exceeds Mechanical Limits	<input checked="" type="checkbox"/> Guaranteed No Problem	<input checked="" type="checkbox"/> Guaranteed No Problem	<input checked="" type="checkbox"/> Guaranteed No Problem	<input checked="" type="checkbox"/> Guaranteed No Problem



GUARANTEED - None of these major title problems were reported by a state Department of Motor Vehicles (DMV). If you find that any of these title problems were reported by a DMV and not included in this report, CARFAX will buy this vehicle back.
 Register | View Terms | View Certificate

CARFAX Additional History

Not all accidents / issues are reported to CARFAX

	Owners 1-2	Owner 3	Owner 4
Total Loss No total loss reported to CARFAX.	<input checked="" type="checkbox"/> No Issues Reported	<input checked="" type="checkbox"/> No Issues Reported	<input checked="" type="checkbox"/> No Issues Reported
Structural Damage CARFAX recommends that you have this vehicle inspected by a collision repair specialist.	<input checked="" type="checkbox"/> No Issues Reported	<input checked="" type="checkbox"/> No Issues Reported	<input checked="" type="checkbox"/> No Issues Reported
Airbag Deployment No airbag deployment reported to CARFAX.	<input checked="" type="checkbox"/> No Issues Reported	<input checked="" type="checkbox"/> No Issues Reported	<input checked="" type="checkbox"/> No Issues Reported
Odometer Check No indication of an odometer rollback.	<input checked="" type="checkbox"/> No Issues Indicated	<input checked="" type="checkbox"/> No Issues Indicated	<input checked="" type="checkbox"/> No Issues Indicated
Accident / Damage Damage reported: 07/14/2015.	<input checked="" type="checkbox"/> No Issues Reported	Damage Reported	No New Issues Reported
Manufacturer Recall Check with an authorized Nissan dealer for any open recalls.	<input checked="" type="checkbox"/> No Recalls Reported	<input checked="" type="checkbox"/> No Recalls Reported	<input checked="" type="checkbox"/> No Recalls Reported
Basic Warranty Original warranty estimated to have expired.	Warranty Expired	Warranty Expired	Warranty Expired

CARFAX Detailed History

Owner 1
Purchased:
2007



Low mileage! This owner drove less than the industry average of 15,000 miles per year.

Date	Mileage	Source	Comments
03/12/2007	6	Arizona Motor Vehicle Dept. Phoenix, AZ Title #9D02007071028	Title or registration issued - First owner reported - Titled or registered as rental vehicle
03/12/2008	9,048	Auto Auction Arizona	Listed as a manufacturer vehicle - Sold at auction - Vehicle sold
04/23/2008	9,358	Online Listing	Vehicle offered for sale
06/17/2008	9,396	Online Listing	Vehicle offered for sale



Millions of used vehicles are bought and sold at auction every year.

Rental Vehicle
9,023 mi/yr

Owner 2
Purchased:
2008



Low mileage! This owner drove less than the industry average of 15,000 miles per year.

Personal Vehicle
7,626 mi/yr

Date	Mileage	Source	Comments
06/26/2008	9,405	Arizona Motor Vehicle Dept. Peoria, AZ	Title or registration issued - New owner reported

Title #0U25008178018

06/30/2008 9,699  **Vehicle serviced**
 - Maintenance inspection completed
 - Tire condition and pressure checked
 - Key(s) (re) programmed

Peoria Nissan
 Peoria, AZ
 623-815-5600
 peorianissan.com

★ 4.5 / 5.0

487 Verified Reviews  **2,961** Customer Favorites

02/12/2009 14,331  **Vehicle serviced**
 - Maintenance inspection completed
 - 3,750 mile service performed
 - Brake pads replaced
 - Tire condition and pressure checked

Peoria Nissan
 Peoria, AZ
 623-815-5600
 peorianissan.com

★ 4.5 / 5.0

487 Verified Reviews  **2,961** Customer Favorites

06/08/2009 16,984  **Vehicle serviced**
 - Maintenance inspection completed
 - Tire condition and pressure checked
 - Oil and filter changed

Peoria Nissan
 Peoria, AZ
 623-815-5600
 peorianissan.com



★ 4.5 / 5.0

487 Verified Reviews  **2,961** Customer Favorites

11/27/2009  **Vehicle serviced**

Acura of Peoria
 Peoria, AZ
 623-974-7600
 acuraofpeoria.com

★ 4.6 / 5.0

182 Verified Reviews  **1,743** Customer Favorites

12/14/2009 20,604  **Vehicle serviced**
 - Recommended maintenance performed
 - Maintenance inspection completed
 - Tires rotated
 - Oil and filter changed

Peoria Kia
 Peoria, AZ
 623-933-6900
 peortakia.com

Owner 3Purchased:
2011

Low mileage! This owner drove less than
 the industry average of 15,000 miles per
 year.

Personal Vehicle
 11,787 mi/yr

Date	Mileage	Source	Comments
01/03/2011		Colorado Motor Vehicle Dept.	Vehicle purchase reported
01/03/2011	29,007	Arizona Motor Vehicle Dept. Peoria, AZ Title #BA70011003006	Title or registration issued - New owner reported
07/07/2011	36,450	Peoria Nissan Peoria, AZ 623-815-5600 peorianissan.com ★ 4.5 / 5.0 487 Verified Reviews 	Vehicle serviced - Maintenance inspection completed - Recommended maintenance performed
05/14/2012	46,627	Peoria Nissan Peoria, AZ 623-815-5600 peorianissan.com	Vehicle serviced - Maintenance inspection completed - Oil and filter changed

★ 4.5 / 5.0

487 [Verified Reviews](#)

♥ 2,961 [Customer Favorites](#)

06/05/2012 47,000

Arizona
Inspection Station
Maricopa County

Passed emissions inspection

06/26/2012 47,748

BRAKES PLUS #207
Peoria, AZ
623-362-0058



Vehicle serviced

- Maintenance inspection completed
- Brakes checked
- Brakes serviced
- Front brake caliper(s) replaced
- Brake pads replaced
- Noise checked
- Steering/suspension checked
- Fluids checked
- Tire condition and pressure checked

★ 4.9 / 5.0

62 [Verified Reviews](#)

♥ 93 [Customer Favorites](#)

07/14/2014 78,873

Colorado
Inspection Station

Passed emissions inspection

07/15/2014

Colorado
Motor Vehicle Dept.
Denver, CO
Title #01G654956

Title or registration issued

- Registration updated when owner moved the vehicle to a new location

03/11/2015 84,940

Grease Monkey #61
Wheat Ridge, CO
303-424-8216
<https://mycarfax.com/signup/grease-monkey-61>



Vehicle serviced

- Power steering fluid flushed/changed
- Oil and filter changed

★ 4.7 / 5.0

61 [Verified Reviews](#)

♥ 210 [Customer Favorites](#)

07/14/2015

Damage Report



Damage reported: moderate damage

- Damage to front
- Damage to right front

This incident was first available for display by CARFAX on 12/05/2017.

CARFAX HAS THE MOST ACCIDENT & DAMAGE INFORMATION

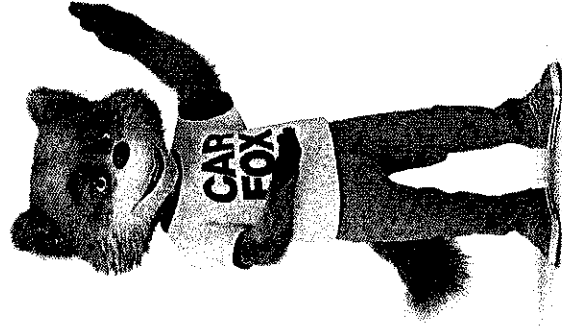

Damage Severity Scale ⓘ



Damage Location

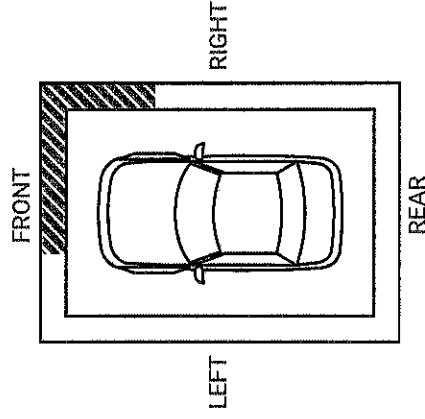

07/29/2015 87,951

Empire Lakewood Nissan
Lakewood, CO

Vehicle serviced

- ♥ Maintenance inspection completed

303-232-8881
empirelakewoodnissan.com

★ 4.7 / 5.0

562 Verified Reviews 

 **3,277** Customer Favorites

10/05/2015

Colorado
Motor Vehicle Dept.
Denver, CO
Title #01G654956

Registration issued or renewed
- Registration updated when owner moved the vehicle to a new location

12/06/2016

CHRISTOPHERS DODGE RAM
Golden, CO
303-238-7311
cdodge.com

Vehicle serviced 

★ 4.0 / 5.0

126 Verified Reviews 

 **173** Customer Favorites

12/06/2016

Planet Honda
Golden, CO
303-215-4200
planetihonda.com

Vehicle serviced 

- Pre-delivery inspection completed
- Maintenance inspection completed
- Tire(s) balanced
- Tires rotated
- Rear brake pads replaced
- Brake rotor(s) resurfaced
- Front brake pads replaced
- Four tires balanced
- Brakes checked

★ 4.6 / 5.0

897 Verified Reviews 

 **7,660** Customer Favorites

12/06/2016

Planet Hyundai
Golden, CO
720-400-8614
planetihyundai.com

Vehicle serviced 

- Pre-delivery inspection completed
- Maintenance inspection completed
- Vehicle washed/detailed
- Rear brake pads replaced
- Brake rotor(s) resurfaced
- Oil cooler seal(s) replaced
- Oil and filter changed

★ 4.6 / 5.0

96 Verified Reviews 

 **2,608** Customer Favorites

12/10/2016

Planet Honda
Golden, CO
303-215-4200
planetihonda.com

Vehicle offered for sale

★ 4.6 / 5.0

897 Verified Reviews 

 **7,660** Customer Favorites

12/14/2016

Colorado
Inspection Station

Passed emissions inspection

12/15/2016

Colorado
Motor Vehicle Dept.
Denver, CO
Title #01G654956

Registration issued or renewed

01/21/2017

Planet Honda
Golden, CO
303-215-4200
planetihonda.com

Vehicle sold

★ 4.6 / 5.0

897 Verified Reviews 

 **7,660** Customer Favorites

Owner 4

Purchased:
2017



Low mileage! This owner drove less than the industry average of 15,000 miles per year.

Personal Vehicle
5,181 mi/yr

Date	Mileage	Source	Comments
01/21/2017		Colorado Motor Vehicle Dept.	Vehicle purchase reported
03/01/2017		Colorado Motor Vehicle Dept. Littleton, CO Title #11R935818	Title issued or updated - New owner reported - Loan or lien reported
04/04/2017		Colorado Motor Vehicle Dept. Littleton, CO Title #11R935818	Registration issued or renewed - Loan or lien reported
08/09/2018		Colorado Motor Vehicle Dept. Littleton, CO Title #11R935818	Title or registration issued - Loan or lien reported - Registration updated when owner moved the vehicle to a new location
05/24/2019	115,583	Dakota Ridge Complete Auto Littleton, CO 303-795-2600 dakotaridgeauto.com ★ 4.4 / 5.0 23 Verified Reviews ♥️ 70 Customer Favorites	Vehicle serviced - Power steering hose(s)/line(s) replaced - Vehicle washed/detailed - Tire repaired - Tires rotated - Tire condition and pressure checked - Oil and filter changed - Fluids checked - Steering/suspension lubricated - Air filter checked - Fuel injection system flushed/serviced
05/31/2019	115,774	Colorado Inspection Station	Passed emissions inspection
05/31/2019		Colorado Motor Vehicle Dept. Littleton, CO Title #11R935818	Registration issued or renewed - Title or registration issued - Loan or lien reported
07/31/2019		Service Facility Bow Mar, CO	Vehicle serviced - Windshield repaired
12/04/2019	121,339	Family Tire & Auto Service Center Parker, CO 303-790-8473 familytireandautoservice.com/ ★ 4.8 / 5.0 17 Verified Reviews ♥️ 22 Customer Favorites	Vehicle serviced - Four wheel alignment performed - Tire(s) replaced - Tire condition and pressure checked - Lower control arm(s) replaced - Wheels checked - Tire pressure monitoring system serviced
12/30/2019	121,420	Family Tire & Auto Service Center Parker, CO 303-790-8473 familytireandautoservice.com/ ★ 4.8 / 5.0 17 Verified Reviews ♥️ 22 Customer Favorites	Vehicle serviced - Tire condition and pressure checked - Tire(s) replaced
02/01/2020	122,219	Meineke Car Care Center Highlands Ranch, CO 303-741-6842 meineke.com ★ 4.8 / 5.0 16 Verified Reviews ♥️ 27 Customer Favorites	Vehicle serviced - Maintenance inspection completed - Oil and filter changed
10/17/2020	125,123	Meineke Car Care Center Highlands Ranch, CO 303-741-6842 meineke.com ★ 4.8 / 5.0 16 Verified Reviews ♥️ 27 Customer Favorites	Vehicle serviced - Front brake caliper(s) replaced - Front brake pads replaced - Rear brake rotor(s) replaced - Brake fluid flushed/changed - Front brake rotor(s) replaced - Rear brake pads replaced - Brake rotor(s) replaced - Safety inspection performed

07/11/2021 126,642 Larry H. Miller Nissan Highlands Ranch Highlands Ranch, CO Vehicle offered for sale

Have Questions? Consumers, please visit our Help Center at www.carfax.com. Dealers or Subscribers, please visit our Help Center at www.carfaxonline.com.



Glossary

Damage Indicator

Damage can be a result of many different types of events. Examples include contact with objects (other cars, trees, traffic signs, road debris, etc), vandalism, or weather-related events. Not every damage event is reported to CARFAX. As details about the damage event become available, those additional details are added to the CARFAX Vehicle History Report. CARFAX recommends that you have this vehicle inspected by a qualified mechanic.

- This CARFAX Vehicle History Report is based only on information supplied to CARFAX and available as of 7/14/21 at 7:33:33 AM (CDT). Other information about this vehicle, including problems, may not have been reported to CARFAX. Use this report as one important tool, along with a vehicle inspection and test drive, to make a better decision about your next used car.

Damage Severity

Damage events result in one of the following severity levels:

- Minor: Generally, minor damage is cosmetic (including dents or scratches), may only require reconditioning, and typically does not compromise a vehicle's operation and/or safety.
- Moderate: Moderate damage may affect multiple components of the vehicle and may impair the vehicle's operation and/or safety.
- Severe: Severe damage usually affects multiple components of the vehicle and is likely to compromise the vehicle's operation and/or safety.

CARFAX recommends getting a pre-purchase inspection at a certified collision repair facility.

First Owner

When the first owner(s) obtains a title from a Department of Motor Vehicles as proof of ownership.

New Owner Reported

When a vehicle is sold to a new owner, the Title must be transferred to the new owner(s) at a Department of Motor Vehicles.

Ownership History

CARFAX defines an owner as an individual or business that possesses and uses a vehicle. Not all title transactions represent changes in ownership. To provide estimated number of owners, CARFAX proprietary technology analyzes all the events in a vehicle history. Estimated ownership is available for vehicles manufactured after 1991 and titled solely in the US including Puerto Rico. Dealers sometimes opt to take ownership of a vehicle and are required to in the following states: Maine, Massachusetts, New Jersey, Ohio, Oklahoma, Pennsylvania and South Dakota. Please consider this as you review a vehicle's estimated ownership history.

Rental

Vehicle was registered by a rental agency.

Title Issued

A state issues a title to provide a vehicle owner with proof of ownership. Each title has a unique number. Each title or registration record on a CARFAX report does not necessarily indicate a change in ownership. In Canada, a registration and bill of sale are used as proof of ownership.

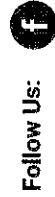

[facebook.com/CARFAX](https://www.facebook.com/CARFAX)



[@CARFAXinc](https://twitter.com/CARFAXinc)



[About CARFAX](#)

CARFAX DEPENDS ON ITS SOURCES FOR THE ACCURACY AND RELIABILITY OF ITS INFORMATION. THEREFORE, NO RESPONSIBILITY IS ASSUMED BY CARFAX OR ITS AGENTS FOR ERRORS OR OMISSIONS IN THIS REPORT. CARFAX FURTHER EXPRESSLY DISCLAIMS ALL WARRANTIES, EXPRESS OR IMPLIED, INCLUDING ANY IMPLIED WARRANTIES OF MERCHANTABILITY OR FITNESS FOR A PARTICULAR PURPOSE.

© 2021 CARFAX, Inc., a unit of IHS Markit Ltd. All rights reserved.
7/14/21 7:33:33 AM (CDT)

I have reviewed and received a copy of the CARFAX Vehicle History Report for this 2007 NISSAN ALTIMA vehicle (VIN: 1N4AL21E37C161216), which is based on information supplied to CARFAX and available as of 7/14/21 at 8:33 AM (EDT).